

CLM-601 CAMERA LINK™ MULTIPLEXER

User's Manual

Document # 200519, Rev 1.0, 09/22/06

© Vivid Engineering
418 Boston Turnpike #104 • Shrewsbury, MA 01545
Phone 508.842.0165 • Fax 508.842.8930
Email info@vividengineering.com
Web www.vividengineering.com

Table of Contents

1.	Introduction	1
1.1.	Overview	1
1.2.	Features	3
1.3.	Functional Description	4
1.4.	Camera Selection	6
1.4.1.	Camera Select Switch	7
1.4.2.	Baud Rate Switch	9
1.4.3.	Serial Control	10
1.4.3.1.	RS-232 Serial Port Communication	10
1.4.3.2.	Camera Link™ Serial Communication	12
1.5.	Typical Application	13
1.6.	Specifications	14
2.	Interface	15
2.1.	Front Panel Connections	15
2.2.	Rear Panel Connections	16
2.2.1.	DB9 Connector Signals	17
2.3.	Camera Connector Signals	18
2.3.1.	Cable Shield Grounding	18
3.	Mechanical	20
3.1.	Dimensions	20
3.2.	External Power Supply	21
4.	Regulatory Compliance	22
4.1.	FCC Compliance Statement	22

4.2.	Canadian Compliance Statement	22
5.	Revision History	23

1. Introduction

1.1. Overview

The CLM-601 Camera Link™¹ Multiplexer interfaces up-to four base configuration Camera Link™ cameras to one frame grabber using standard Camera Link™ cables. This capability supports applications requiring the ability to select between multiple cameras. The CLM-601 incorporates high-speed (85 MHz) interfaces and works with any base camera.

The CLM-601 provides multiple camera selection methods including rear-panel switch settings, Camera Link™ interface signals (serial or camera control), and an external RS-232 port. Medium configuration cameras are supported using two CLM-601s in parallel. Multiple CLM-601s may be cascaded to support more than four cameras.

The CLM-601 Camera Link™ Multiplexer is housed in a sturdy, compact aluminum enclosure and is well suited for industrial and OEM applications.

¹ The Camera Link™ interface standard enables the interoperability of cameras and frame grabbers, regardless of vendor. The Automated Imaging Association (AIA) sponsors the Camera Link™ program including the oversight Camera Link Committee, the self-certification program, and the product registry. The Camera Link™ specification may be downloaded from the AIA website, found at www.machinevisiononline.org

Camera Link™ is a trademark of the Automated Imaging Association

Windows™ is a trademark of Microsoft Corporation

HyperTerminal™ is a trademark of Hilgraeve Inc.

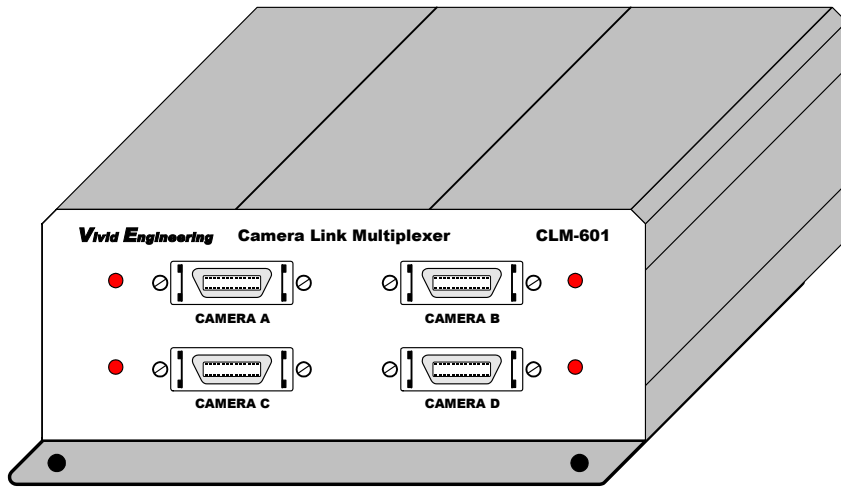

1.2. Features

- Interfaces up-to four cameras to one frame grabber
- High-speed (85 MHz) design supports all base configuration cameras
- Multiple camera selection methods:
 - Camera Link™ interface serial messages
 - Camera Link™ interface Camera Control (CC) signals
 - Standard RS-232 port
 - Fixed selection via switch settings
- Passes all interface signals (video data, serial comm, camera control)
- May be cascaded to support greater than four cameras
- Medium configuration support using two CLM-601s
- LED camera select indicators
- Sturdy, compact aluminum enclosure w/ mounting flange
- Optional external power supply
- RS-232 cable included
- FCC Class A regulatory compliance
- 3-year warrantee

1.3. Functional Description

A block diagram of the CLM-601 is provided in Figure 1-1. The CLM-601 interfaces up to four base configuration Camera Link™ cameras to one frame grabber using standard Camera Link™ cables. This capability supports applications requiring the ability to select between multiple cameras.

The cameras, denoted A/B/C/D, connect to the front of the CLM-601, and the frame grabber connects to the rear. The camera selection method is determined by the Camera Select switch located on the rear panel. The camera selection options are:

- Camera Link™ serial port messages
- Camera Link™ Camera Control signals (CC1/CC2 or CC3/CC4)
- External RS-232 serial port messages
- Fixed selection (A,B,C, or D)

When serial communication (Camera Link™ or RS-232) is used to select the camera, the data rate is specified via the rear panel baud rate switch. The baud switch enables the user to operate the CLM-601 at the same data rate as the camera, so camera and CLM-601 control messages can be combined on the same serial link. More details are provided in Section 1.4.3.

LED camera select indicators are located next to the camera connectors to identify the current camera selection.

Multiple CLM-601s may be cascaded to support more than four cameras. Medium configuration cameras can be supported using two CLM-601s.

The CLM-601 camera and frame grabber interfaces incorporate the connector, signals, pinout, and chipset in compliance with the Camera Link™ specification. The CLM-601 incorporates the “base” (single cable) configuration signal set, consisting of video data, camera control, and serial communications. The CLM-601 incorporates high-speed (85 MHz) interfaces and supports any base configuration camera.

The CLM-601 Camera Link™ Multiplexer is housed in a sturdy, compact aluminum enclosure and is well suited for industrial and OEM applications.

The CLM-601 is powered by an external wall plug-in power supply (optional). A null modem cable for use with the RS-232 port is included.

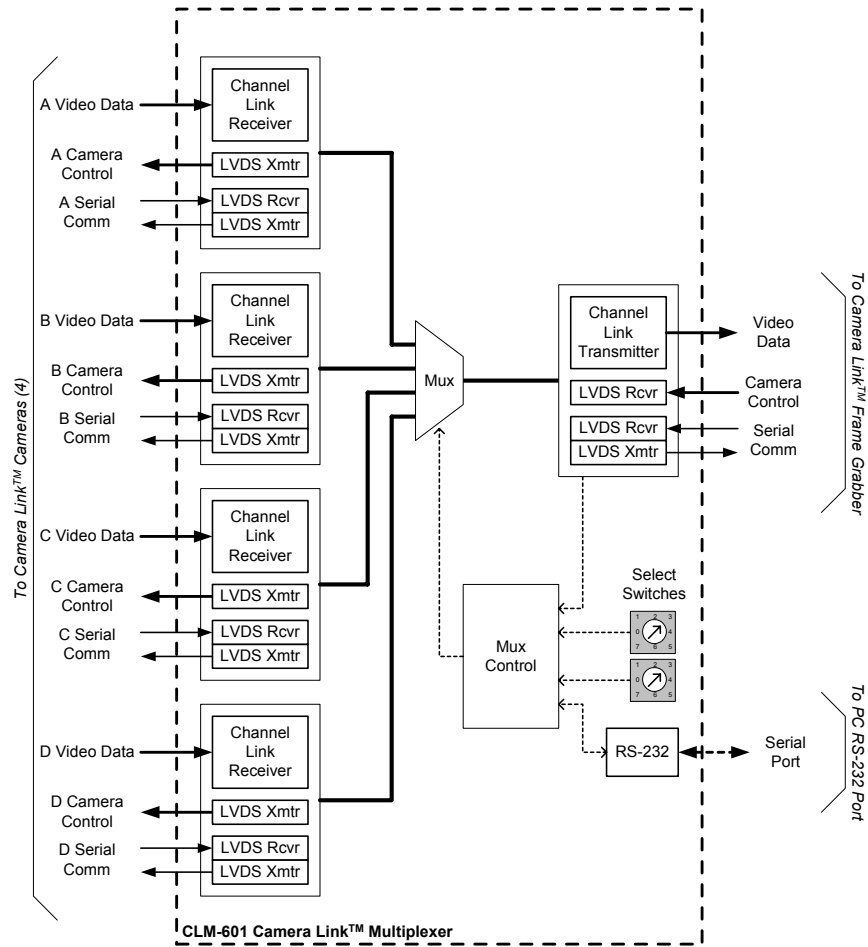

Figure 1-1: CLM-601 Block Diagram

1.4. Camera Selection

The CLM-601 supports a variety of camera selection methods. The different methods are described in the following sections. The camera selection mode is determined by the camera select switch located on the rear panel. The rear panel also includes a baud rate switch for use with the serial control modes. The rear-panel switches are shown in Figure 1-2.

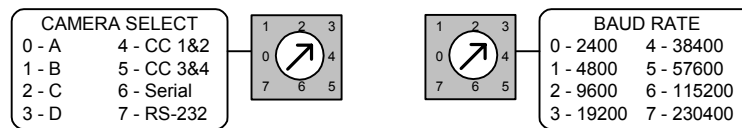

Figure 1-2: Rear-Panel Select Switches

Note that camera selection changes are “hard” switches. The camera selection is performed immediately. As a precaution, care should be used to pause/halt the frame grabber while the switch is being made to avoid frame grabber malfunction.

1.4.1. Camera Select Switch

The Camera select switch provides eight camera selection modes. The camera select modes are defined in Table 1-1. The selection modes are described in the following sections.

Table 1-1: Camera Select Modes

Camera Select Switch	Mode
0	Camera A
1	Camera B
2	Camera C
3	Camera D
4	Camera Control CC1 & CC2
5	Camera Control CC3 & CC4
6	Camera Link™ serial link
7	RS-232 serial port

Switch positions 0-3 provide fixed camera A/B/C/D selection. Camera selection is fixed (static) and is unaffected by the camera control signal states or the serial control messages.

Switch positions 4-5 enable camera selection based on the states of the Camera Control (CC) that are part of the Camera Link™ interface. Camera selection may be made by CC signals 1&2, or by 3&4. Camera Control signals 3&4 are often unused by the camera and are available for controlling the multiplexer. Switch position 4 selects the camera based on the states of CC1 & CC2 as shown in Table 1-2. Switch position 5 selects the camera based on the states of CC3 & CC4 as shown in Table 1-3. Note that the frame grabber must hold the CC lines in a steady (static) state.

Table 1-2: CC1/CC2 Mode (Switch = 4)

CC2	CC1	Mode
0	0	Camera A
0	1	Camera B
1	0	Camera C
1	1	Camera D

Table 1-3: CC3/CC4 Mode (Switch = 5)

CC4	CC3	Mode
0	0	Camera A
0	1	Camera B
1	0	Camera C
1	1	Camera D

1.4.2. Baud Rate Switch

The serial control modes operate at the data rate identified by the baud rate switch. The ability to select the baud rate is of particular use when the Camera Link™ serial communication link is being used to control both the camera and the CLM-601. The CLM-601 can be set to operate at the same data rate as the camera, enabling the transfer of control messages to the camera along with control messages to the CLM-601. The baud rate switch settings are listed in Table 1-4.

Table 1-4: Baud Rate Settings

Camera Select Switch Position	Select Mode
0	2400
1	4800
2	9600
3	19200
4	38400
5	57600
6	115200
7	230400

1.4.3. Serial Control

The serial communication modes (Switch positions 6&7) enable camera selection via control messages over the Camera Link™ serial link or through the RS-232 port. When the Camera Select switch is at position 6, the CLM-601 responds to serial messages sent over the serial link in the Camera Link™ interface. When the switch is in position 7, the CLM-601 responds to serial messages sent via the RS-232 port located on the rear panel. The CLM-601 incorporates a simple, single-command, Command Line Interface (CLI) for controlling the CLM-601.

The serial port protocol settings are conventional and are defined in Table 1-5. Note that the baud rate is determined by the Baud Rate switch. 9600 baud is a common rate for control applications.

Table 1-5: Serial Port Settings

Port Characteristic	Setting
Rate (bits per second)	<i>Per Baud Rate Switch</i>
Data Bits	8
Parity	None
Stop Bits	1
Flow Control	None

Note that when in the serial control modes, the CLM-601 will default select camera A following power up.

Slight differences exist between the Camera Link™ serial link and the RS-232 port, which will be pointed out in the following sections.

1.4.3.1. RS-232 Serial Port Communication

CLM-601 camera selection is via the rear-panel RS-232 port when the camera control switch is in position 7. In this mode the CLM-601 is connected to a control computer RS-232 port. The user can control the CLM-601 using communications software such as HyperTerminal™ which is included in the Windows™ operating systems.

The RS-232 serial port incorporates a standard 9-pin D-Sub (DB9) connector. Connector information is provided in Section 2-2. A null modem cable is included for connecting the CLM-601 to a PC serial port.

When in RS-232 mode, the CLM-601 will send the following message to the RS-232 port upon power-up:

```
CLM-601 Camera Link Multiplexer CLI  
Vivid Engineering  
Rev 1.0
```

Note that Camera A will be selected by default following power-up.

The CLM-601 echoes-back all characters received via the RS-232 while in RS-232 mode.

CLM-601 camera selection is controlled via the ASCII CAM_MUX control message of the following form:

```
CAM_MUX x<CR>
```

Where “x” is the character A,B,C,D or ?, and “<CR>” is a carriage return (i.e. RETURN or ENTER on a PC keyboard). . The message must be exactly as shown with one space between “CAM_MUX” and the “A”, “B”, “C”, “D”, or “?”. The message must be immediately followed by a RETURN (i.e. carriage return). The CLM-601 does not support the inclusion of additional spaces, backspace, delete, etc. When “A-D” are entered, the CLM-601 will immediately change selection to the corresponding camera. When “?” is entered, the CLM-601 will respond by returning the current camera selection (A-D).

The message is not case sensitive. Below are a few examples of valid camera selection command messages:

```
CAM_MUX B  
cam_mux C  
Cam_Mux d
```

The following message is an example of a camera selection query in which the CLM-601 returns the currently selected camera, “A”, “B”, “C”, or “D” on the following line:

Cam_Mux ?

A

1.4.3.2. Camera Link™ Serial Communication

CLM-601 camera selection is controlled via the serial communication link in Camera Link™ interface when the camera control switch is in position 6. In this mode, the CLM-601 is controlled via a serial port in the frame grabber. Consult your frame grabber documentation for information about accessing the port.

Controlling the CLM-601 via the Camera Link™ serial link is similar to RS-232 control described in the prior section, except the communication link is unidirectional. The CLM-601 receives the camera control message described, but does not return any messages to the frame grabber. The CLM-601 will not echo received characters, issue the startup message, or support camera query while in this mode. This restriction avoids potential communication conflicts between the camera and the CLM-601 and ensures that the camera control functions normally.

1.5. Typical Application

A typical CLM-601 Camera Link™ Multiplexer application is shown in Figure 1-3. Four different base-configuration cameras are connected to the multiplexer using standard Camera Link™ cables. Another standard cable is used to connect the multiplexer to the frame grabber. Any combination of base configuration cameras may be used including newer high-speed (85 MHz) types.

In this example the CLM-601 RS-232 port is unconnected. Camera selection is being made using either the Camera Link™ interface camera control signals (CC1/CC2 or CC3/CC4) or the Camera Link™ interface serial link.

Note that camera selection changes are “hard” switches. The camera selection is performed immediately. As a precaution, care should be used to pause/halt the frame grabber while the switch is being made to avoid frame grabber malfunction.

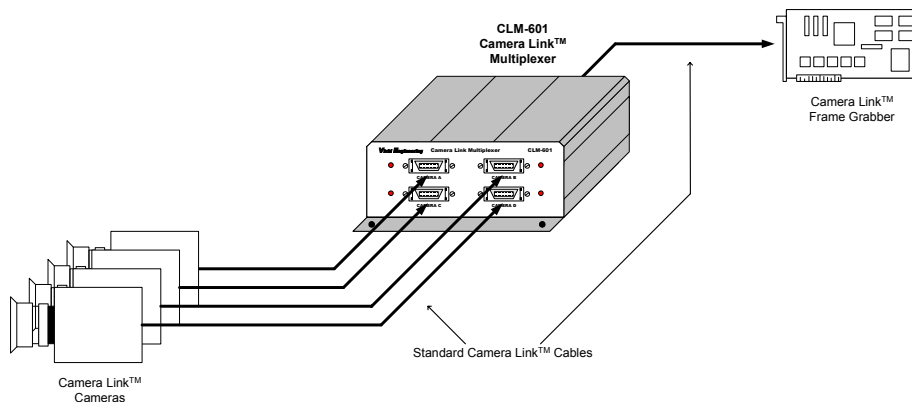

Figure 1-3: CLM-601 Typical Application

1.6. Specifications

Table 1-6: CLM-601 Specifications

Feature	Specification
Camera Interface	Camera Link™ Spec "base" configuration
Camera Connectors	26-pin MDR type (5)
Frequency Range	20 - 85 MHz
Serial Port Interface	RS-232
Serial Port Connector	Male 9-pin D-Sub (DB9)
Serial Port Cable	3 meter DB9 female - DB9 female null modem cable
Chipset	National Semi. DS90CR287 / DS90CR288A
Power Supply	Optional US/Europe Transformer w/ Outlet Plug Set
Power Jack	2.1 x 5.5 mm, center-positive
Power Requirements	5-7 VDC, 400 mA (typical)
Cabinet Dimensions	5.28" (L) x 2.08" (H) x 6.12" (D)
Weight	22 oz
Operating Temperature Range	0 to 50° C
Storage Temperature Range	-25 to 75° C
Relative Humidity	0 to 90%, non-condensing

2. Interface

2.1. Front Panel Connections

The CLM-601 Camera Link™ Multiplexer front panel is shown in Figure 2-1. The front panel contains four video connectors for connecting to the cameras, and four LEDs to identify the selected camera.

The MDR-26 connector is a 3M device as specified in the Camera Link™ Spec. Figure 2-2 identifies the MDR-26 pin positions.

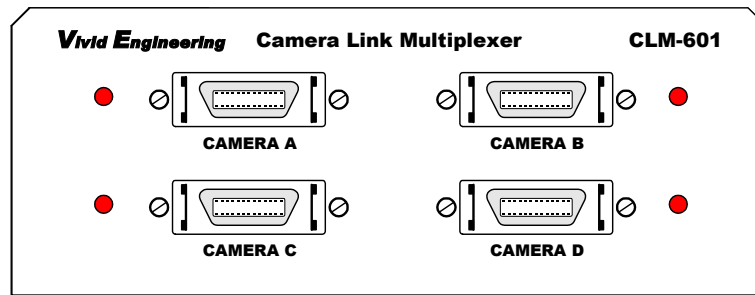

Figure 2-1: CLM-601 Front Panel

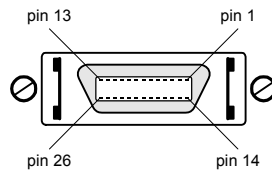

Figure 2-2: MDR-26 Connector Pin Positions

2.2. Rear Panel Connections

The CLM-601 Camera Link™ Multiplexer rear panel is shown in Figure 2-3. The rear panel contains a 26-pin MDR video connector for connecting to the frame grabber, the RS-232 port connector, two select switches, and a DC power jack.

The MDR-26 connector is a 3M device as specified in the Camera Link™ Spec.

The RS-232 serial port connector is a standard 9-pin male D-Sub type (DB9). Figure 2-4 identifies the DB9 pin positions.

The Camera Select and Baud Rate select switches are 8-position rotary style. The switches are recessed to avoid inadvertent changes. A small screwdriver is suggested for changing switch positions.

DC power jack accepts 5-7 volts DC. Polarity is center-positive.

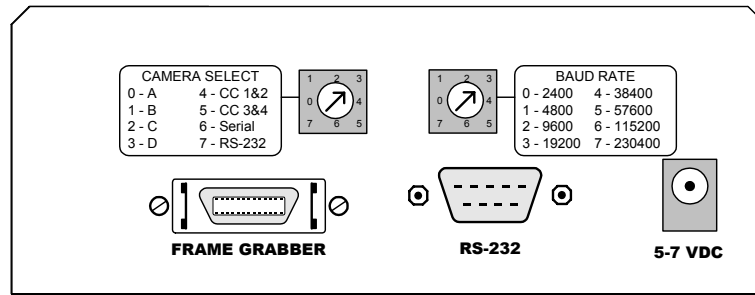

Figure 2-3: CLM-601 Rear Panel

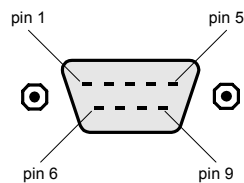

Figure 2-4: DB9 Connector Pin Positions

2.2.1. DB9 Connector Signals

The DB9 connector signal assignments are compliant with the RS-232 serial interface standard. Table 2-1 identifies the DB9 signal assignments.

Table 2-1: DB9 Connector

RS-232 Signal Name	DB9 Pin#	Signal Direction	Notes
Received Line Signal Detect	1	N/A	<i>tied to pins 4 & 6</i>
Received Data	2	PC → CLM-601	
Transmitted Data	3	CLM-601 → PC	
Data Terminal Ready	4	N/A	<i>tied to pins 1 & 6</i>
Signal Ground (common)	5	N/A	<i>tied to digital ground</i>
DCE Ready	6	N/A	<i>tied to pins 1 & 4</i>
Request To Send	7	N/A	<i>tied to pin 8</i>
Clear To Send	8	N/A	<i>tied to pin 7</i>
Ring Indicator	9	N/A	<i>no connection</i>

"PC" = Control PC, workstation, or terminal

2.3. Camera Connector Signals

The MDR-26 video connector signal assignments comply with the Camera Link™ “base” configuration. The *camera* connector signal assignments correspond to the frame grabber interface defined in the Camera Link™ Specification. Conversely, the *frame grabber* connector assignments are as defined for the camera interface in the Camera Link™ Specification. This arrangement provides compatibility with standard Camera Link™ cables.

Table 2-2 identifies the signal assignments for the MDR-26 video connectors.

2.3.1. Cable Shield Grounding

Camera and frame grabber cable “outer” shields are connected to the CLM-601 aluminum case. The case is isolated from the CLM-601 circuitry and the cable “inner” shields.

The frame grabber cable “inner” shield connects to circuit digital ground, maintaining signal reference levels between the CLM-601 and the frame grabber.

The Camera Link™ Specification recommends that a provision be incorporated into frame grabbers that enable the inner shields be tied to digital ground either directly, or through a parallel R/C network. In CLM-601, the *camera connector* represents the Camera Link™ frame grabber interface. To incorporate this flexibility, the CLM-601 ties the inner shields from the camera connector to digital ground through 0-ohm resistors. If necessary, the 0-ohm resistors may be replaced with a parallel RC network.

Table 2-2: MDR-26 Connector Assignments

Camera Link™ Signal Name	Camera Connector Pin # (frame grabber pinout)	Frame Grabber Connectors Pin # (camera pinout)	Signal Direction
Inner shield	1	1	N/A
Inner shield	14	14	N/A
X0-	25	2	CAM → FG
X0+	12	15	CAM → FG
X1-	24	3	CAM → FG
X1+	11	16	CAM → FG
X2-	23	4	CAM → FG
X2+	10	17	CAM → FG
Xclk-	22	5	CAM → FG
Xclk+	9	18	CAM → FG
X3-	21	6	CAM → FG
X3+	8	19	CAM → FG
SerTC+	20	7	FG → CAM
SerTC-	7	20	FG → CAM
SerTFG-	19	8	CAM → FG
SerTFG+	6	21	CAM → FG
CC1-	18	9	FG → CAM
CC1+	5	22	FG → CAM
CC2+	17	10	FG → CAM
CC2-	4	23	FG → CAM
CC3-	16	11	FG → CAM
CC3+	3	24	FG → CAM
CC4+	15	12	FG → CAM
CC4-	2	25	FG → CAM
Inner shield	13	13	N/A
Inner shield	26	26	N/A

"FG" = Frame Grabber, "CAM" = Camera

3. Mechanical

3.1. Dimensions

The CLM-601 Camera Link™ Video splitter cabinet dimensions are shown in Figure 3-1.

The CLM-601 is housed in a sturdy aluminum enclosure. The body is extruded aluminum, with detachable front and rear endplates. The enclosure incorporates a mounting flange. The flange contains four predrilled holes (0.15" diameter) for convenient equipment mounting. A mounting hole template drawing is provided in Figure 3-2.

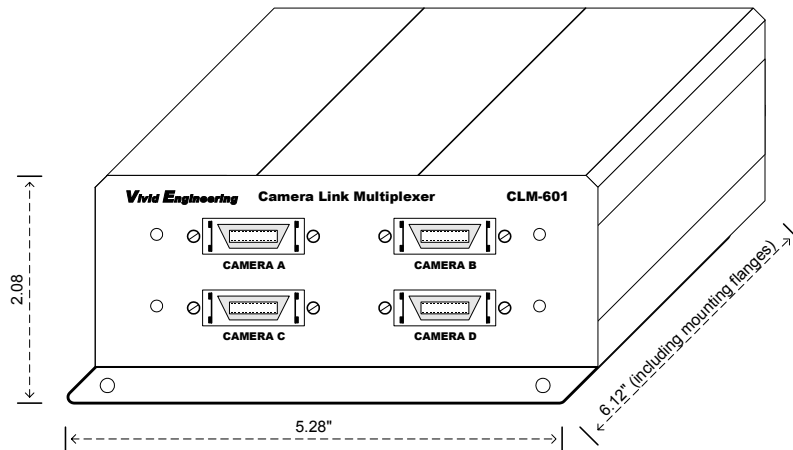

Figure 3-1: CLM-601 Cabinet Dimensions

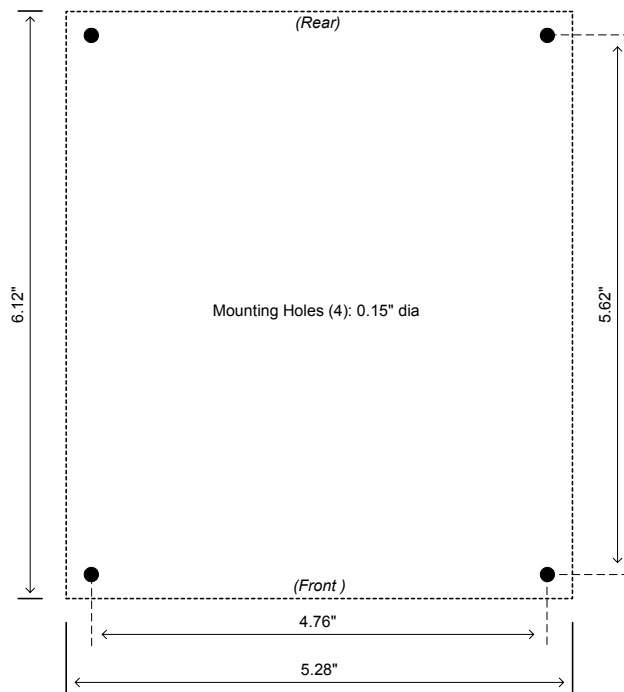

Figure 3-2: Mounting Hole Template

3.2. External Power Supply

The CLM-601 is powered by 5-7 VDC and incorporates a standard 2.1 x 5.5 mm DC power jack. Power plug polarity is center-positive.

The optional multi-nation wall-mount power supply handles a wide power range (90-264 VAC, 47-63 Hz) and comes with a set of outlet plugs suitable for most countries (US, Europe, UK, etc).

The CLM-601 is protected by internal resettable fuses.

4. Regulatory Compliance

4.1. FCC Compliance Statement

This equipment has been tested and found to comply with the limits for a Class A digital device, pursuant to Part 15 of the FCC Rules. These limits are designed to provide a reasonable protection against harmful interference when the equipment is operated in a commercial environment. Operation of this equipment in a residential area is likely to cause harmful interference in which case the user will be required to correct the interference at his/her own expense.

Changes or modifications not expressly approved by the party responsible for compliance could void the user's authority to operate the equipment.

4.2. Canadian Compliance Statement

This digital apparatus does not exceed the Class A limits for radio noise emissions from digital apparatus set out in the Radio Interference Regulations of the Canadian Department of Communications.

5. Revision History

Table 5-1: CLM-601 User's Manual Revision History

Document ID #	Date	Changes
200519-1.0	9/22/06	Initial release of manual