

CLM-602 CAMERA LINK MULTIPLEXER

User's Manual

Document # 201232, Rev 0.1, 2/17/2014 (**preliminary**)

© Vivid Engineering
159 Memorial Drive, Suite F • Shrewsbury, MA 01545
Phone 508.842.0165 • Fax 508.842.8930
Email info@vividengineering.com
Web www.vividengineering.com

Table of Contents

1.	Introduction	1
1.1.	Overview	1
1.2.	Features	2
1.3.	Functional Description	3
1.4.	Camera Selection	6
1.4.1.	Camera Select Switch	7
1.4.2.	Baud Rate Switch	9
1.4.3.	Serial Control	10
1.4.3.1.	USB Support (Optional)	10
1.4.3.2.	RS-232 Serial Port Communication	11
1.4.3.3.	Camera Link Serial Communication	13
1.5.	Typical Application	14
1.6.	Specifications	15
2.	Interface	16
2.1.	Front Panel Connections	16
2.2.	Rear Panel Connections	17
2.2.1.	DB9 Connector Signals	18
2.3.	Video Connectors	19
2.4.	Cable Shield Grounding	19
3.	Mechanical	20
3.1.	Dimensions	20
3.2.	External Power Supply	21
4.	Revision History	22

1. Introduction

1.1. Overview

The CLM-602 Camera Link¹ Multiplexer interfaces two Camera Link cameras of any configuration (base, medium, full, 80-bit) to one frame grabber using standard Camera Link cables. This capability supports applications requiring the ability to switch between multiple cameras. The CLM-602 incorporates high-speed (85 MHz) interfaces and works with any Camera Link camera.

The CLM-602 provides multiple camera selection methods including rear-panel switch settings, Camera Link interface signals (serial or camera control), and an external RS-232 port. An inexpensive optional adapter supports control of the CLM-602 via a PC USB port.

The CLM-602 Camera Link Multiplexer is housed in a sturdy, compact aluminum enclosure.

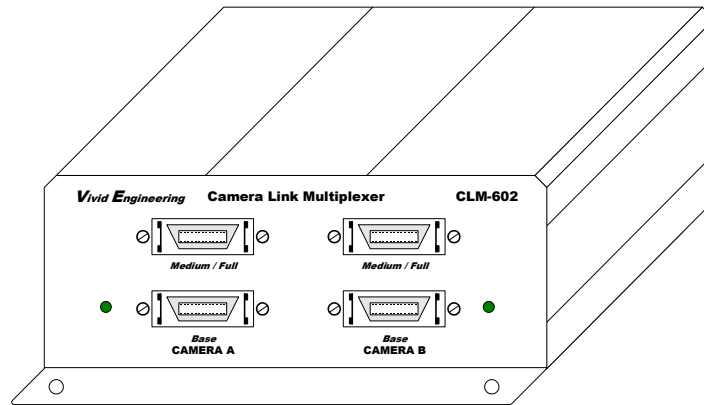

¹ The Camera Link interface standard enables the interoperability of cameras and frame grabbers, regardless of vendor. The Automated Imaging Association (AIA) sponsors the Camera Link program including the oversight Camera Link Committee, the self-certification program, and the product registry. The Camera Link specification may be downloaded from the AIA website, found at www.machinevisiononline.org

1.2. Features

- Interfaces two cameras to one frame grabber
- Supports all Camera Link configurations (base, medium, full, 80-bit)
- High-speed (85 MHz) design supports all Camera Link cameras
- Multiple camera selection methods:
 - Camera Link interface serial messages
 - Camera Link interface Camera Control (CC) signals
 - Standard RS-232 port
 - Standard USB port (w/ optional adapter)
 - Fixed switch settings
- Passes all interface signals (video data, serial comm, camera control)
- Minimal video data pass-through latency: 3 camera pixel clocks
- Minimal control/communication pass-through latency: under 15 nS
- LED camera select indicators
- Sturdy, compact aluminum enclosure w/ mounting flange
- Isolated DC power input
- Multi-nation power supply included, locking-plug power supply optional
- RS-232 cable included
- 3-year warrantee

1.3. Functional Description

A block diagram of the CLM-602 is provided in Figure 1-1. The CLM-602 interfaces two base, medium, full, or 80-bit configuration Camera Link cameras to one frame grabber using standard Camera Link cables. This capability supports applications requiring the ability to switch between cameras.

The CLM-602 is essentially an “electronic” version of an electromechanical switch. When commanded, the CLM-602 instantaneously disconnects from one camera and connects to the other.

The two cameras, denoted A&B, connect to the front of the CLM-602. The frame grabber connects to the rear. The camera selection method is determined by the Camera Select switch located on the rear panel. The camera selection options are:

- Camera Link serial port messages
- Camera Link Camera Control signals (CC1, CC2, CC3 or CC4)
- External RS-232 (or USB w/ optional adapter) serial port messages
- Fixed selection (A or B)

When serial communication (Camera Link or RS-232/USB) is used to select the camera, the data rate is specified via the rear panel baud rate switch. The baud switch enables the user to operate the CLM-602 at the same data rate as the camera, so camera and CLM-602 control messages can be combined on the same serial link. More details are provided in Section 1.4.3.

The CLM-602 camera and frame grabber interfaces incorporate the connector, signals, pinout, and chipset in compliance with the Camera Link specification. The CLM-602 incorporates the “full” (i.e. dual cable) configuration signal set, consisting of video data, camera control, and serial communications. The CLM-602 also works with 80-bit, medium configuration and base configuration (single cable) configuration cameras. The CLM-602 incorporates high-speed (85 MHz) interfaces.

The CLM-602 adds minimal delay (i.e. latency) to the video data path. This is an important criterion for time-critical applications. The latency through the CLM-602 is a fixed 3 pixel-clock delay. The pixel clock is established by the camera and can range from 20-85 MHz. Therefore, the CLM-602 fixed delay can range from 35 to 150 nS, depending on camera. The delay added by the CLM-602 for the camera control and serial communication signals is under 15 nS.

LED camera select indicators are located next to the camera connectors to identify the current camera selection.

The CLM-602 DC power input is electrically isolated from the internal circuitry. This feature ensures compatibility with user power systems.

The CLM-602 is powered by an external wall plug-in power supply. A multi-nation power supply is standard. Optionally, the CLM-602 is available with a locking-plug power supply. The locking plug reduces the risk of accidental disconnection from the rear-panel power jack. The CLM-602 is also available without power supply. An RS-232 serial cable is included.

The CLM-602 Camera Link Multiplexer is housed in a sturdy, compact aluminum enclosure.

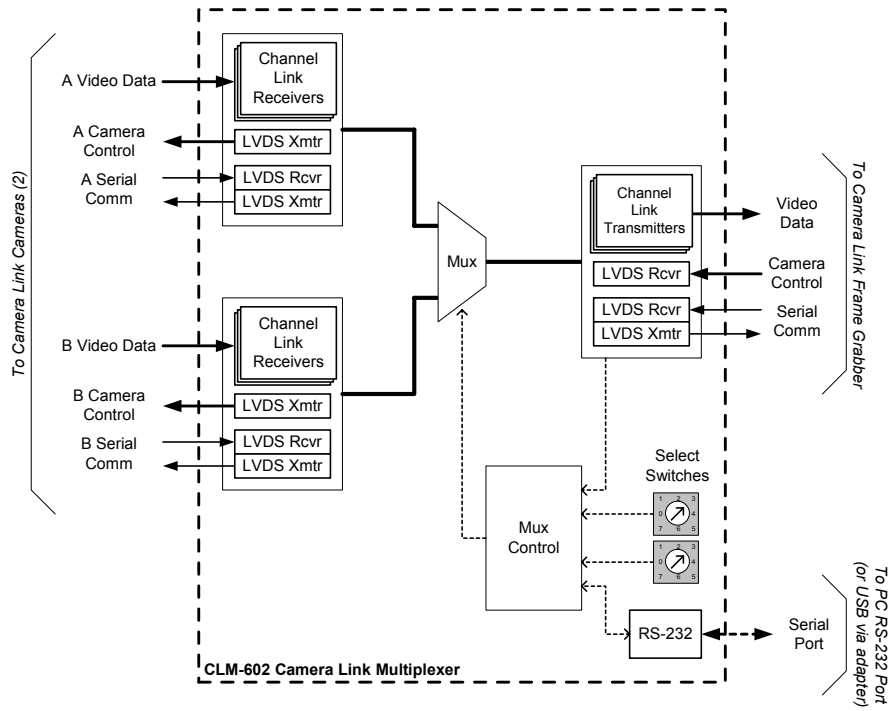

Figure 1-1: CLM-602 Block Diagram

1.4. Camera Selection

The CLM-602 supports a variety of camera selection methods. The different methods are described in the following sections. The camera selection mode is determined by the camera select switch located on the rear panel. The rear panel also includes a baud rate switch for use with the serial control modes. The rear-panel switches are shown in Figure 1-2.

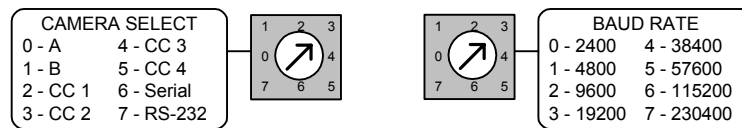

Figure 1-2: Rear-Panel Select Switches

Note that camera selection changes are “hard” switches. The camera selection is performed immediately. Care should be used while switching to pause/halt/reset the frame grabber as required to avoid malfunction.

1.4.1. Camera Select Switch

The camera select switch provides eight camera selection modes. The camera select modes are defined in Table 1-1. The selection modes are described in the following sections.

Table 1-1: Camera Select Modes

Camera Select Switch	Mode
0	Camera A
1	Camera B
2	Camera Control CC1
3	Camera Control CC2
4	Camera Control CC3
5	Camera Control CC4
6	Camera Link serial link
7	RS-232 serial port (or USB)

Switch positions 0-1 provide fixed camera A/B selection. Camera selection is fixed (static) and is unaffected by the camera control signal states or the serial control messages.

Switch positions 2-5 enable camera selection based on the states of the Camera Control (CC) that are part of the Camera Link interface. Camera selection may be made by CC signals 1,2,3, or 4. Camera Control signals 3-4 are generally unused by cameras and are available for controlling the multiplexer. Switch positions 2-5 select the camera based on the CC states shown in Table 1-2 through 1-5. Note that the frame grabber must hold the CC lines in a steady (static) state.

Table 1-2: CC1 Mode (Switch = 2)

CC1	Mode
0	Camera A
1	Camera B

Table 1-3: CC2 Mode (Switch = 3)

CC2	Mode
0	Camera A
1	Camera B

Table 1-4: CC3 Mode (Switch = 4)

CC3	Mode
0	Camera A
1	Camera B

Table 1-5: CC4 Mode (Switch = 5)

CC4	Mode
0	Camera A
1	Camera B

1.4.2. Baud Rate Switch

The serial control modes operate at the data rate identified by the baud rate switch. The ability to select the baud rate is of particular use when the Camera Link serial communication link is being used to control both the camera and the CLM-602. The CLM-602 can be set to operate at the same data rate as the camera, enabling the transfer of control messages to the camera along with control messages to the CLM-602. The baud rate switch settings are listed in Table 1-6.

Table 1-6: Baud Rate Settings

Camera Select Switch Position	Select Mode
0	2400
1	4800
2	9600
3	19200
4	38400
5	57600
6	115200
7	230400

1.4.3. Serial Control

The serial communication modes (Switch positions 6&7) enable camera selection via control messages over the Camera Link serial link or through the external serial port (RS-232, or USB with optional adapter). When the Camera Select switch is at position 6, the CLM-602 responds to serial messages sent over the serial link in the Camera Link interface. When the switch is in position 7, the CLM-602 responds to serial messages sent via the RS-232 port located on the rear panel (or USB port via optional adapter). The CLM-602 incorporates a simple, single-command, Command Line Interface (CLI) for controlling the CLM-602.

The serial port protocol settings are conventional and are defined in Table 1-5. Note that the baud rate is determined by the baud rate switch. 9600 baud is a common rate for control applications.

Table 1-5: Serial Port Settings

Port Characteristic	Setting
Rate (bits per second)	<i>Per Baud Rate Switch</i>
Data Bits	8
Parity	None
Stop Bits	1
Flow Control	None

Note that when in the serial control modes, the CLM-602 will default select camera A following power up.

Slight differences exist between the Camera Link serial link and the RS-232/USB port, which will be pointed out in the following sections.

1.4.3.1. USB Support (Optional)

USB can be used, instead of RS-232, for the external serial port using an optional external USB to serial RS-232 adapter. This eliminates the problem with using newer desktop and laptop computers that do not incorporate a serial port. One side of the USB to serial adapter plugs into the PC USB port. The other side of

the adapter connects to the RS-232 serial cable included with the CLM-602. Once installed, the PC will create a new serial COM port that may be accessed using the PC in the same fashion as the standard RS-232 serial port. Driver software installation may be required.

A tested and inexpensive USB to serial converter is available from Vivid Engineering. These converters are readily available online (i.e. Amazon).

1.4.3.2. RS-232 Serial Port Communication

CLM-602 camera selection is via the rear-panel RS-232 port when the camera control switch is in position 7. In this mode the CLM-602 is connected to a control computer RS-232 port (or USB port using optional adapter). The user can control the CLM-602 using communications software such as HyperTerminal. CLM-602 control may also be incorporated into a user's control program via standard COM port commands.

The RS-232 serial port incorporates a standard 9-pin D-Sub (DB9) connector. Connector information is provided in Section 2-2. A null modem cable is included for connecting the CLM-602 to a PC serial port (or USB adapter, if used).

When in RS-232 mode, the CLM-602 will send the following message to the RS-232 port upon power-up:

```
CLM-602 Camera Link Multiplexer CLI  
Vivid Engineering  
Rev 1.0
```

Note that Camera A will be selected by default following power-up.

The CLM-602 will not echo-back characters received via the RS-232 port.

CLM-602 camera selection is controlled via the ASCII CAM_MUX control message of the following form:

```
CAM_MUX x
```

Where "x" is the character A,B, or ?. The message must be exactly as shown with one space between "CAM_MUX" and the "A", "B", or "?". The message must be immediately followed by an ASCII carriage return or new line (i.e.

RETURN or ENTER on a PC keyboard). The CLM-602 does not support the inclusion of additional spaces, backspace, delete, etc. When “A” or “B” are entered, the CLM-602 will immediately change selection to the corresponding camera. When “?” is entered, the CLM-602 will respond by returning the current camera selection (A or B).

The messages are not case sensitive. Below are a few examples of valid camera selection command messages:

```
CAM_MUX B  
cam_mux A  
Cam_Mux a
```

The following message is an example of a camera selection query in which the CLM-602 returns the currently selected camera; “A” or “B”.

Message sent to CLM-602:

```
Cam_Mux ?
```

Response from CLM-602:

```
A
```

1.4.3.3. Camera Link Serial Communication

CLM-602 camera selection is controlled via the serial communication link in Camera Link interface when the camera control switch is in position 6. In this mode, the CLM-602 is controlled via a serial port in the frame grabber. Consult your frame grabber documentation for information about accessing the port.

Controlling the CLM-602 via the Camera Link serial link is similar to RS-232 control described in the prior section, except the communication link is unidirectional. The CLM-602 receives the camera control message described, but does not return any messages to the frame grabber. The CLM-602 will not issue the startup message, or support camera query while in this mode. This restriction avoids potential communication conflicts between the camera and the CLM-602 and ensures that camera control functions normally.

1.5. Typical Application

A typical CLM-602 Camera Link Multiplexer application is shown in Figure 1-3. Two full-configuration cameras are connected to the multiplexer using standard Camera Link cable pairs. Another cable pair is used to connect the multiplexer to the frame grabber. Note that the cameras need not be identical. Any combination of base, medium, full, 80-bit configuration cameras may be used.

In this example the CLM-602 RS-232 port is unconnected.

Note that camera selection changes are “hard” switches. The camera selection is performed immediately. Care should be used to pause/halt/reset the frame grabber during the switch if necessary to avoid malfunction.

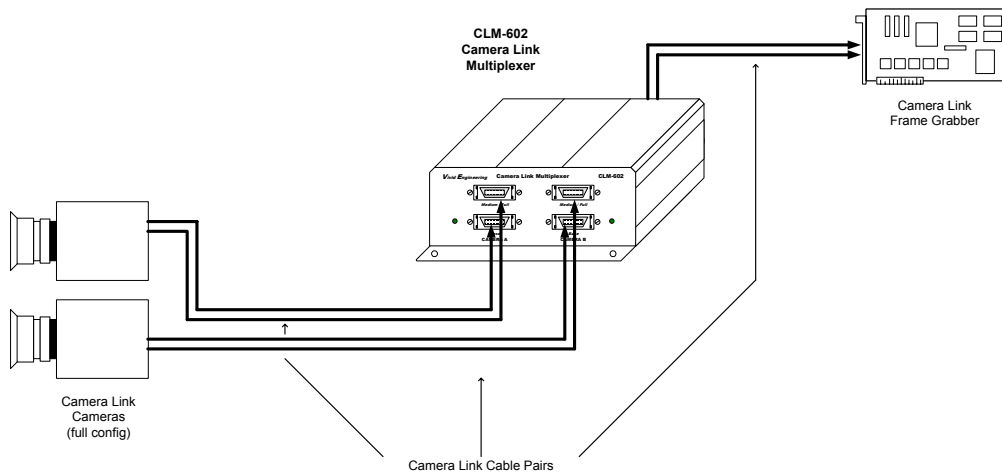

Figure 1-3: CLM-602 Typical Application

1.6. Specifications

Table 1-6: CLM-602 Specifications

Feature	Specification
Video Interfaces	Camera Link Spec "full" configuration (with 80-bit support)
Video Connectors	26-pin MDR type
Frequency Range	20 - 85 MHz
Latency	Video path: 3 camera pixel clock cycles Control & communication: 15ns max
Serial Port	Standard RS-232 w/ 9-pin male D-Sub connector (DB9)
Serial Cable	3 meter DB9 female - DB9 female null modem cable included
Power Supply	Universal wall style w/ outlet plug set
Power Plug	2.1 x 5.5 mm, center-positive. Locking style optional.
Power Requirements	4.5 – 9 VDC, internally isolated xxx mA @ 5 VDC (typical)
Cabinet Dimensions	5.28" (L) x 2.08" (H) x 6.12" (D)
Weight	xx oz
Operating Temperature Range	0 to 50° C
Storage Temperature Range	-25 to 75° C
Relative Humidity	0 to 90%, non-condensing

2. Interface

2.1. Front Panel Connections

The CLM-602 Camera Link Multiplexer front panel is shown in Figure 2-1. The front panel contains six four-pin MDR video connectors; two for camera A, and two for camera B. Two LEDs identify the selected camera.

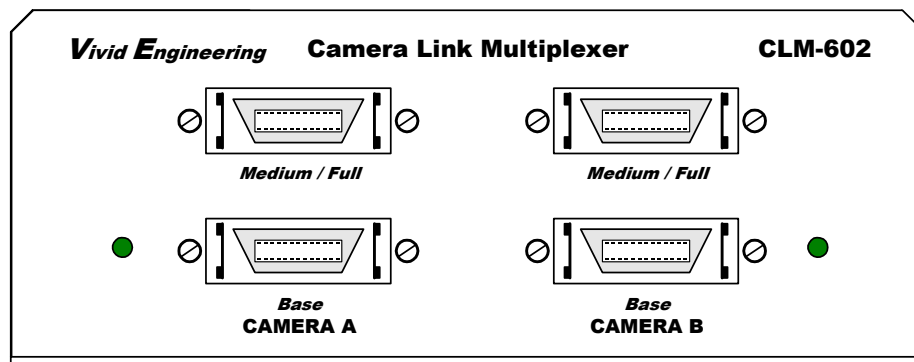

Figure 2-1: CLM-602 Front Panel

2.2. Rear Panel Connections

The CLM-602 Camera Link Multiplexer rear panel is shown in Figure 2-3. The rear panel contains two 26-pin MDR video connectors for connecting to the frame grabber, the RS-232 port connector, two select switches, and the DC power jack.

The RS-232 serial port connector is a standard 9-pin male D-Sub type (DB9). Figure 2-4 identifies the DB9 pin positions.

The Camera Select and Baud Rate select switches are 8-position rotary style. The switches are recessed to avoid inadvertent changes. A small screwdriver is suggested for changing switch positions.

The DC power jack accepts either a standard 2.1 x 5.5 mm barrel-style power plug or a special locking plug. The locking plug has bayonet-style “ears” on the barrel. Once inserted, the plug is turned ¼ turn clockwise. This locks the connection and provides retention. Plug polarity is center-positive. The recommended locking power plug is Philmore part number 2150.

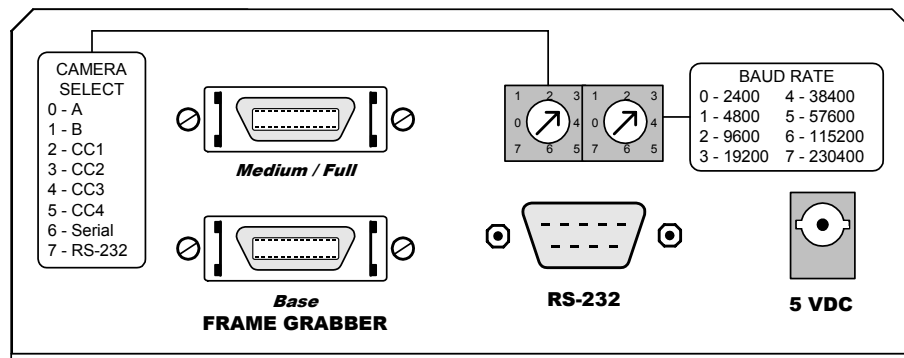

Figure 2-3: CLM-602 Rear Panel

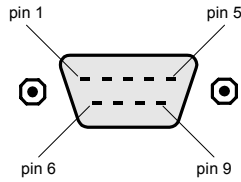

Figure 2-4: DB9 Connector Pin Positions

2.2.1. DB9 Connector Signals

The DB9 connector signal assignments are compliant with the RS-232 serial interface standard. Table 2-1 identifies the DB9 signal assignments.

Table 2-1: DB9 Connector

RS-232 Signal Name	DB9 Pin#	Signal Direction	Notes
Received Line Signal Detect	1	N/A	<i>tied to pins 4 & 6</i>
Received Data	2	PC → CLM-602	
Transmitted Data	3	CLM-602 → PC	
Data Terminal Ready	4	N/A	<i>tied to pins 1 & 6</i>
Signal Ground (common)	5	N/A	<i>tied to digital ground</i>
DCE Ready	6	N/A	<i>tied to pins 1 & 4</i>
Request To Send	7	N/A	<i>tied to pin 8</i>
Clear To Send	8	N/A	<i>tied to pin 7</i>
Ring Indicator	9	N/A	<i>no connection</i>

"PC" = Control PC

2.3. Video Connectors

The MDR-26 video connector signal assignments comply with the Camera Link “full” configuration, providing compatibility with all Camera Link cameras and frame grabbers (base, medium, full, 80-bit). The *camera* connector signal assignments correspond to the frame grabber interface defined in the Camera Link Specification. Conversely, the *frame grabber* connector assignments are as defined for the camera interface in the Camera Link Specification. This arrangement provides compatibility with standard Camera Link cables.

2.4. Cable Shield Grounding

Camera and frame grabber cable “outer” shields are connected to the CLM-602 aluminum case. Case and endplate contacting surfaces are unpainted, providing a Faraday cage to shield internal circuitry. The case is isolated from the CLM-602 circuitry and the cable “inner” shields.

The camera and frame grabber cable “inner” shields connects to circuit digital ground, maintaining signal reference levels between the cameras and the CLM-602. and between the CLM-602 and the frame grabber.

3. Mechanical

3.1. Dimensions

The CLM-602 Camera Link Video splitter cabinet dimensions are shown in Figure 3-1.

The CLM-602 is housed in a sturdy aluminum enclosure. The body is extruded aluminum, with detachable front and rear endplates. The enclosure incorporates a mounting flange. The flange contains four predrilled holes (0.15" diameter) for convenient equipment mounting. A mounting footprint drawing is provided in Figure 3-2.

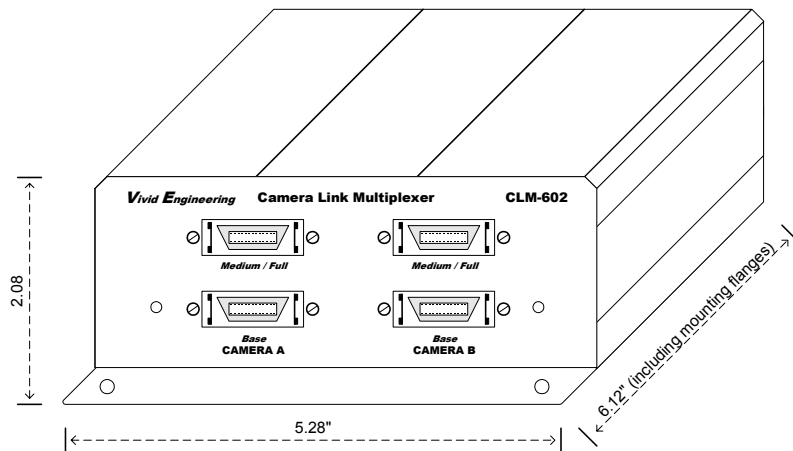

Figure 3-1: CLM-602 Cabinet Dimensions

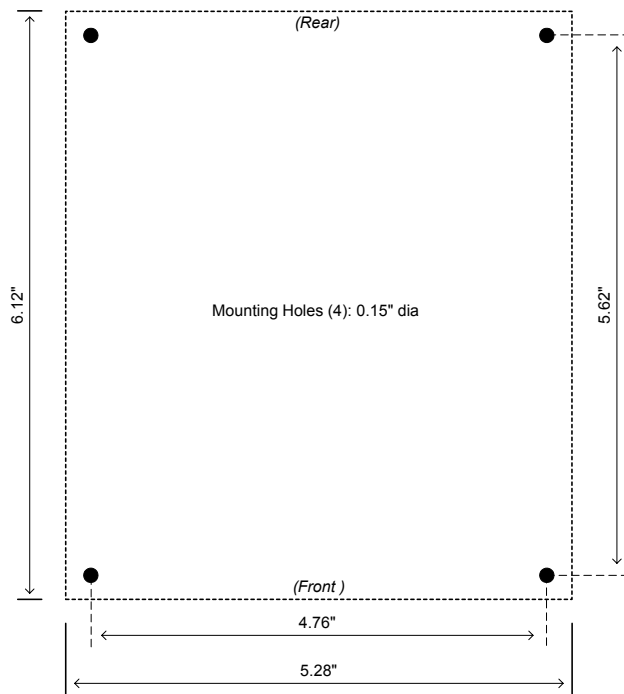

Figure 3-2: Mounting Footprint Drawing

3.2. External Power Supply

The CLM-602 is powered by 4.5 – 9.0 VDC and incorporates a 2.1 x 5.5 mm DC power jack that accepts either a standard barrel-style power plug, or a special locking version (see Section 2.2). Power plug polarity is center-positive.

The CLM-602 includes a multi-nation wall-mount power supply that handles a wide power range (90-264 VAC, 47-63 Hz) and comes with a set of outlet plugs suitable for most countries (US, Europe, UK, etc). The CLM-602 may also be purchased with a locking-plug power supply, or without power supply.

4. Revision History

Table 5-1: CLM-602 User's Manual Revision History

Document ID #	Date	Changes
201232 -0.1	2/17/14	Preliminary release of manual