

CLV-411 CAMERA LINK VIDEO SPLITTER

User's Manual

Document # 200587, Rev 1.0, 5/1/2009

© Vivid Engineering
418 Boston Turnpike #104 • Shrewsbury, MA 01545
Phone 508.842.0165 • Fax 508.842.8930
www.vividengineering.com • info@vividengineering.com

Table of Contents

1.	Introduction	1
1.1.	Overview	1
1.2.	Features	3
1.3.	Functional Description	4
1.3.1.	Master Frame Grabber Selection	6
1.4.	Typical Applications	7
1.4.1.	Standard Base Application	7
1.4.2.	Medium Application	8
1.5.	Specifications	9
2.	Interface	10
2.1.	Front Panel Connections	10
2.2.	Rear Panel Connections	11
2.2.1.	Master Select Connector	12
2.3.	Camera Connector Signals	13
2.3.1.	Cable Shield Grounding	13
3.	Mechanical	15
3.1.	Dimensions	15
3.2.	External Power Supply	16
4.	Regulatory Compliance	17
4.1.	FCC Compliance Statement	17
4.2.	Canadian Compliance Statement	17
5.	Revision History	18

1. Introduction

1.1. Overview

The CLV-411 Camera Link^{TM1} Video Splitter interfaces one Camera Link camera to up-to four frame grabbers using standard Camera Link cables. This enables the use of multiple frame grabbers for applications requiring parallel or distributed processing, camera sharing, etc. One frame grabber acts as master and provides control and communications to the camera. The remaining frame grabbers receive camera video data only. The master frame grabber is selectable and may be dynamically changed for applications requiring camera control sharing.

The CLV-411 incorporates high-speed 85 MHz interfaces and supports the Camera Link base configuration. Medium configuration applications are supported using two CLV-411s. Multiple CLV-411s may be cascaded for large parallel processing systems.

The CLV-411 Camera Link Video Splitter is housed in a sturdy, compact aluminum enclosure.

¹ The Camera LinkTM interface standard enables the interoperability of cameras and frame grabbers, regardless of vendor. The Automated Imaging Association (AIA) sponsors the Camera LinkTM program including the oversight Camera Link Committee, the self-certification program, and the product registry. The Camera LinkTM specification may be downloaded from the AIA website, found at www.machinevisiononline.org

Camera LinkTM is a trademark of the Automated Imaging Association

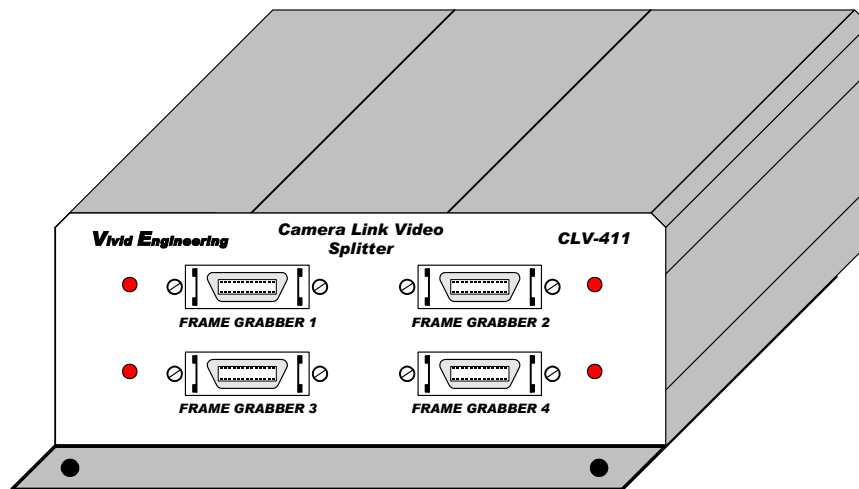

1.2. Features

- Interfaces one camera to up-to four frame grabbers
- Supports parallel or distributed processing, camera sharing, etc
- Uses standard Camera Link cables (not included)
- Supports Camera Link Base configuration
- Medium configuration support using two CLV-411s
- May be cascaded for large parallel processing systems
- High-speed 85 MHz interface chipset
- Dynamic master frame grabber selection via opto-isolated control inputs
- Front panel LEDs identify master frame grabber
- Flow-through connector positioning
- Sturdy, compact aluminum enclosure w/ mounting flange
- Universal power supply included
- 3-year warrantee

1.3. Functional Description

A block diagram of the CLV-411 is provided in Figure 1-1. The CLV-411 interfaces one camera to up-to four frame grabbers using standard Camera Link cables.

One frame grabber acts as the master (primary). The master frame grabber receives video data from the camera, and can also control and communicate with the camera. The interface between the camera and the *master* frame grabber utilizes the entire Camera Link signal set defined in the Camera Link Specification for “base” configurations. This consists of video data, camera control, and serial communications.

The remaining frame grabbers act as slaves (secondary). The interface between the camera and the *slave* frame grabbers utilizes video data only. The slave frame grabbers receive video data, but cannot control or communicate with the camera.

Some applications require the ability to share control of the camera between the frame grabbers (i.e. share the master role). CLV-411 allows any of the four frame grabbers to act as the master. Selection of the master frame grabber is made via the opto-isolated master select inputs. When the select inputs change, the master frame grabber is immediately reassigned accordingly. This enables dynamic (i.e. real-time) selection of the master frame grabber for applications requiring this capability.

Frame grabber 1 is the default master frame grabber whenever the opt-isolated inputs are not being used. Front panel LED indicators identify the current master frame grabber.

Since the CLV-411 regenerates all signals, it also acts as a repeater and supports an additional 10 meters of separation between camera and frame grabbers.

The CLV-411 is also compatible with the second Camera Link cable used in the “medium” configuration, enabling a pair of CLV-411s to be used in parallel to support medium configuration applications.

The CLV-411 is powered by an external wall plug-in power supply.

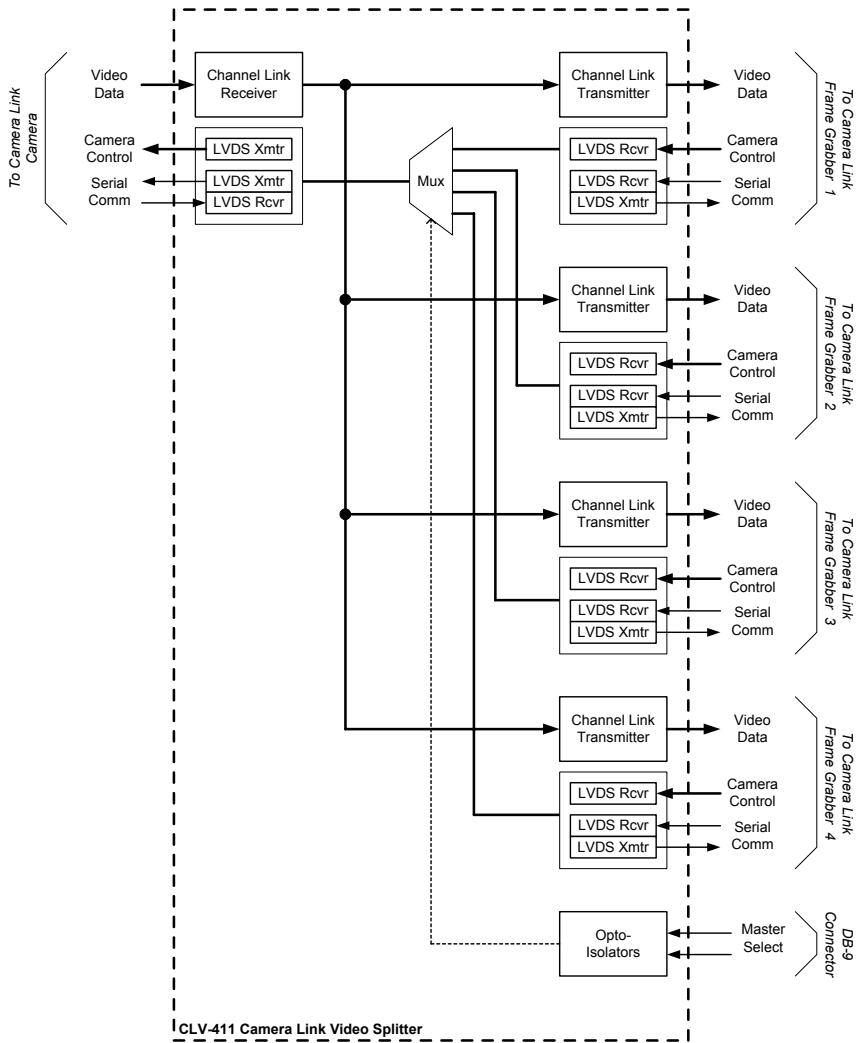

Figure 1-1: CLV-411 Block Diagram

1.3.1. Master Frame Grabber Selection

Master frame grabber selection is supported via the master select port. Note that the use of this port is optional.

Two opto-isolated control inputs are provided via a DB9 connector on the rear panel. Voltage levels applied to these inputs select the master frame grabber. Master reassignment occurs instantaneously, enabling real-time master selection. When no connection is made to the DB9, Frame Grabber 1 is master (default). See Section 2.2.1 for connector pin assignments and signal characteristics.

The front-panel indicator LEDs identify the current master frame grabber.

Table 1-1: Master Frame Grabber Select Inputs

SEL1	SEL0	Master Frame Grabber
0	0	Frame Grabber 1
0	1	Frame Grabber 2
1	0	Frame Grabber 3
1	1	Frame Grabber 4
<i>No Connection</i>		Frame Grabber 1

1.4. Typical Applications

1.4.1. Standard Base Application

A typical CLV-411 base application is shown in Figure 1-2. A Camera Link base configuration camera is connected to a single CLV-411 via a standard Camera Link cable. Additional Camera Link cables are then used to connect the CLV-411 to up-to four Camera Link frame grabbers.

Since the master select port is not being used in this example, frame grabber 1 is the default master. The master frame grabber provides camera control and communication, as well as performing processing functions. The slave frame grabbers cannot control or communicate with the camera, but are used for parallel or distributed processing, monitoring, etc.

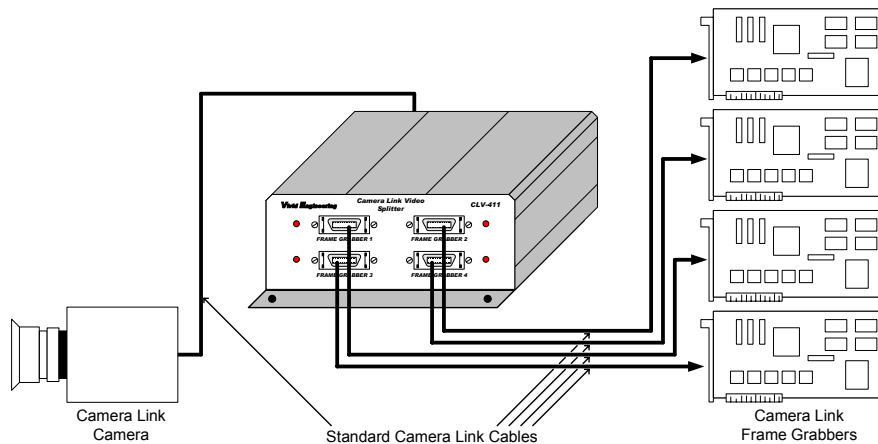

Figure 1-2: CLV-411 Standard Application (Base)

1.4.2. Medium Application

A CLV-411 medium application is shown in Figure 1-3. Medium configurations, in which two cables connect the camera to the frame grabbers, are supported using two CLV-411s in parallel. A Camera Link medium configuration camera is connected to two CLV-411s via a pair of standard Camera Link cables. Additional Camera Link cables are then used to connect the CLV-411s to the Camera Link frame grabbers.

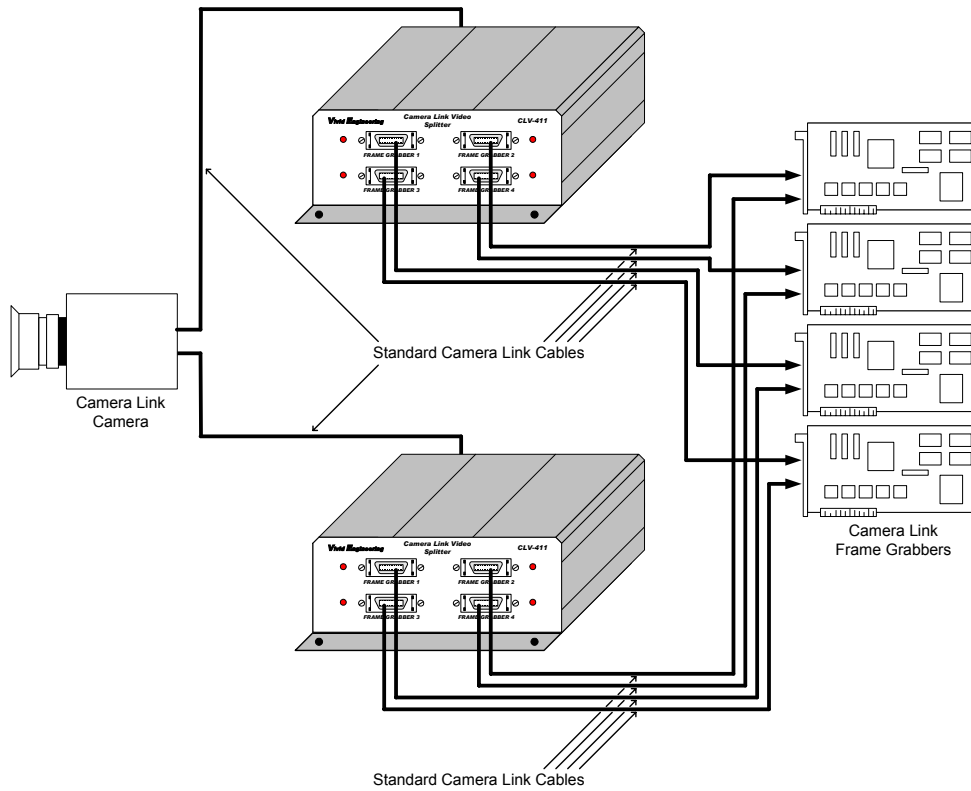

Figure 1-3: CLV-411 “Medium” Application

1.5. Specifications

Table 1-1: CLV-411 Specifications

Feature	Specification
Video Interfaces	Camera Link "base" configuration
Video Connectors	26-pin MDR type
Camera Frequency	20-85 MHz
Chipset	National Semi. DS90CR287 / DS90CR288A
Select Connector	Female 9-pin D-Sub (DB9), opto-isolated inputs
Power Supply	Universal wall style w/ US & Europe outlet plugs
Power Jack	2.1 x 5.5 mm, center-positive
Power Requirements	5-7 VDC, 380 mA (typical)
Cabinet Dimensions	5.28" (L) x 2.08" (H) 6.12" (D)
Weight	20 oz
Operating Temperature Range	0 to 50° C
Storage Temperature Range	-25 to 75° C
Relative Humidity	0 to 90%, non-condensing
Compliance	FCC Class A, ROHS, (CE EN55024 pending)

2. Interface

2.1. Front Panel Connections

The CLV-411 Camera Link Video Splitter front panel is shown in Figure 2-1. The front panel contains four video connectors for connecting to the frame grabbers. The four LEDs identify which frame grabber is “master” as discussed in prior sections.

The video connectors are 3M MDR-26 types as specified in the Camera Link Spec. Figure 2-2 identifies the MDR-26 pin positions.

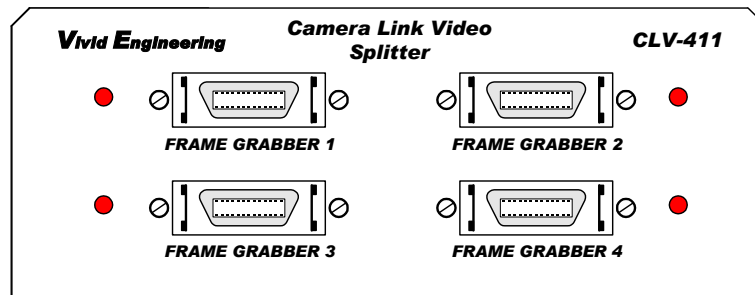

Figure 2-1: CLV-411 Front Panel

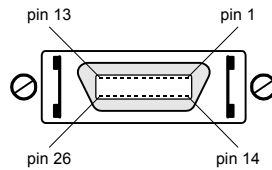

Figure 2-2: MDR-26 Connector Pin Positions

2.2. Rear Panel Connections

The CLV-411 Camera Link Video Splitter rear panel is shown in Figure 2-3. The rear panel contains a 26-pin MDR video connector for connecting to the camera, the master select connector, and a DC power jack.

The MDR-26 connector is a 3M device as specified in the Camera Link Spec.

The master select connector is a standard 9-pin female D-Sub type (DB9). Figure 2-4 identifies the DB9 pin positions.

DC power jack accepts 5-7 volts DC. Polarity is center-positive.

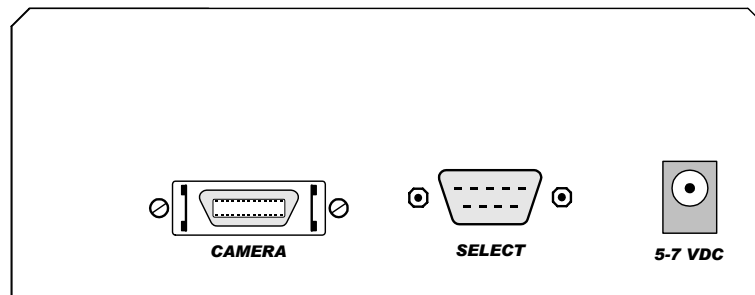

Figure 2-3: CLV-411 Rear Panel

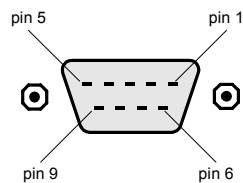

Figure 2-4: Female DB9 Connector Positions

2.2.1. Master Select Connector

A standard female DB9 connector is located on the rear panel for master frame grabber selection. Use of this connector is optional. The CLV-411 will default to frame grabber 1 as master when no connection is made. Table 2-1 identifies the DB9 signal assignments.

Table 2-1: Master Select DB9 Connector

Signal Name	DB9 Pin#	Notes
SEL0 +	1	<i>Master Select 0</i>
n/c	2	<i>no connection</i>
n/c	3	<i>no connection</i>
SEL1 +	4	<i>Master Select 1</i>
n/c	5	<i>no connection</i>
SEL0 -	6	<i>Master Select 0 Return</i>
n/c	7	<i>no connection</i>
n/c	8	<i>no connection</i>
SEL1 -	9	<i>Master Select 1 Return</i>

Two control inputs (SEL0+/- & SEL1+/-) are used to select the master frame grabber. The control inputs are received by opto-isolator devices for system electrical isolation.

SEL0 is logic "1" when 5-10 VDC is applied between SEL0+ and SEL0-. SEL0 is logic "0" when 0 VDC is applied. Similarly, SEL1 is logic "1" when 5-10 VDC is applied between SEL1+ and SEL1-. SEL1 is logic "0" when 0 VDC is applied.

2.3. Camera Connector Signals

The MDR-26 video connector signal assignments comply with the Camera Link “base” configuration. The *camera* connector signal assignments correspond to the frame grabber interface defined in the Camera Link Specification. Conversely, the *frame grabber* connector assignments are as defined for the camera interface in the Camera Link Specification. This arrangement provides compatibility with standard Camera Link cables.

Table 2-2 identifies the signal assignments for the MDR-26 video connectors.

2.3.1. Cable Shield Grounding

Camera and frame grabber cable “outer” shields are connected to the CLV-411 aluminum case. The case is isolated from the CLV-411 circuitry and the cable “inner” shields.

The frame grabber cable “inner” shield connects to circuit digital ground, maintaining signal reference levels between the CLV-411 and the frame grabber.

Table 2-2: MDR-26 Connector Assignments

Camera Link Signal Name	Camera Connector Pin # (frame grabber pinout)	Frame Grabber Connectors Pin # (camera pinout)	Signal Direction
Inner shield	1	1	N/A
Inner shield	14	14	N/A
X0-	25	2	CAM → FG
X0+	12	15	CAM → FG
X1-	24	3	CAM → FG
X1+	11	16	CAM → FG
X2-	23	4	CAM → FG
X2+	10	17	CAM → FG
Xclk-	22	5	CAM → FG
Xclk+	9	18	CAM → FG
X3-	21	6	CAM → FG
X3+	8	19	CAM → FG
SerTC+	20	7	FG → CAM
SerTC-	7	20	FG → CAM
SerTFG-	19	8	CAM → FG
SerTFG+	6	21	CAM → FG
CC1-	18	9	FG → CAM
CC1+	5	22	FG → CAM
CC2+	17	10	FG → CAM
CC2-	4	23	FG → CAM
CC3-	16	11	FG → CAM
CC3+	3	24	FG → CAM
CC4+	15	12	FG → CAM
CC4-	2	25	FG → CAM
Inner shield	13	13	N/A
Inner shield	26	26	N/A

"FG" = Frame Grabber, "CAM" = Camera

3. Mechanical

3.1. Dimensions

The CLV-411 Camera Link Video splitter cabinet dimensions are shown in Figure 3-1.

The CLV-411 is housed in a sturdy aluminum enclosure. The body is extruded aluminum, with detachable front and rear endplates. The enclosure incorporates a mounting flange. The flange contains four predrilled holes (0.15" diameter) for convenient equipment mounting. A mounting drawing is provided in Figure 3-2.

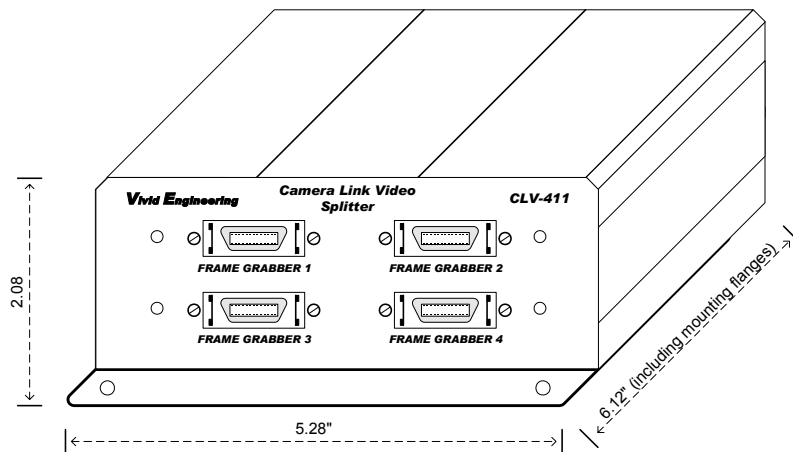

Figure 3-1: CLV-411 Cabinet Dimensions

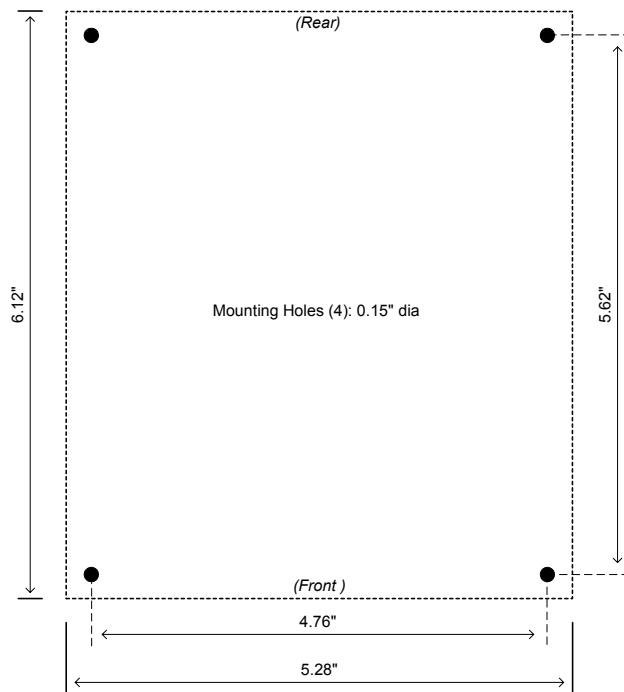

Figure 3-2: Mounting Template

3.2. External Power Supply

The CLV-411 is powered by 5-7 VDC and incorporates a standard 2.1 x 5.5 mm DC power jack. Power plug polarity is center-positive.

The multi-nation wall-mount power supply (included) handles a wide power range (90-264 VAC, 47-63 Hz) and comes with a set of outlet plugs suitable for most countries (US, Europe, UK, etc).

The CLV-411 is protected by an internal resettable fuse.

4. Regulatory Compliance

4.1. FCC Compliance Statement

This equipment has been tested and found to comply with the limits for a Class A digital device, pursuant to Part 15 of the FCC Rules. These limits are designed to provide a reasonable protection against harmful interference when the equipment is operated in a commercial environment. Operation of this equipment in a residential area is likely to cause harmful interference in which case the user will be required to correct the interference at his/her own expense.

Changes or modifications not expressly approved by the party responsible for compliance could void the user's authority to operate the equipment.

4.2. Canadian Compliance Statement

This digital apparatus does not exceed the Class A limits for radio noise emissions from digital apparatus set out in the Radio Interference Regulations of the Canadian Department of Communications.

5. Revision History

Table 5-1: CLV-411 User's Manual Revision History

Document ID #	Date	Changes
200587-1.0	5/1/09	Initial release of manual